

PRODUCTS

- [Products Home](#)
- [Size Table](#)
- [Accessories](#)
- [Customization](#)
- [A-Series](#)
- [C-Series](#)
 - [C-Home](#)
 - [C-4](#)
 - [C-6](#)
 - [C-8](#)
 - [C-10](#)
 - [C-12](#)
 - [C-28](#)
- [CA-Series](#)
- [CH-Series](#)
- [G-Series](#)
- [H-Series](#)
- [M-Series](#)
- [R-Series](#)
- [RX-Series](#)
- [S-Series](#)
- [SL-Series](#)

Products: C-Series

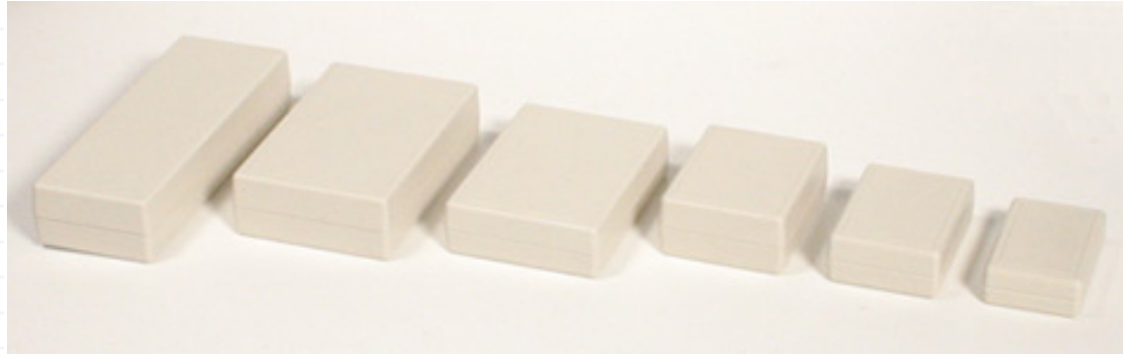

[FEATURES](#)

[COLORS](#)

[MODELS](#)

[ACCESSORIES](#)

FEATURES

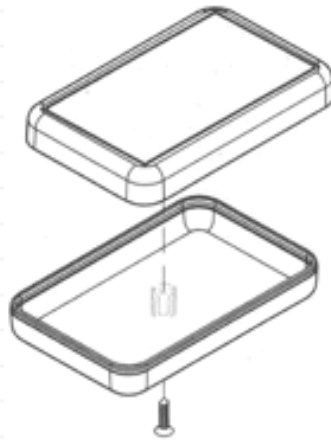

- Two-piece design
- Accepts 0.031" thick circuit board trapped on outer perimeter and central boss
- In-stock translucent colors for select models
- Single screw assembly
- Customization available
 - two insert areas/I-Plates ([top and bottom](#))
 - [machining](#)
 - [pad printing](#)

COLORS



Black



Almond







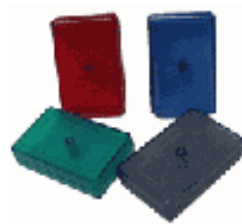













Gray

[Custom Colors Also Available](#)



Translucent colors ; red, green, blue and gray are stocked on models: C-4, C-6, C-8 & C-10

MODEL	IMAGE (click photo for full specs)	LENGTH	WIDTH	HEIGHT	DRAWINGS	
					(.pdf)	(.dwg)
C-4		2.125"	1.375"	0.580"		
C-6		2.263"	1.613"	0.753"		
C-8		2.400"	1.850"	0.925"		
C-10		2.300"	3.250"	0.800"		
C-12		2.400"	3.750"	1.000"		
C-28		5.000"	1.850"	1.000"		

ACCESSORIES (Click an accessory for compatible models and part numbers)



Key Holder



Pocket Clip

[RETURN TO TOP](#)

[Home](#) | [About SERPAC](#) | [Products](#) | [Accessories](#) | [Customizations](#) | [Distributors](#) | [Buy Now!](#) | [Contact Us](#)

PRODUCTS: [A-Series](#) | [C-Series](#) | [CA-Series](#) | [CH-Series](#) | [G-Series](#) | [H-Series](#) | [M-Series](#) | [R-Series](#) | [S-Series](#) | [SL-Series](#)

© 2004, SERPAC Electronic Enclosures. All Rights Reserved